

Operator and Parts Manual



JOLLY MAX Tile Saws

Versions:

Jolly Max 200 230v

Jolly Max 230 230v

Fairport Construction Equipment manufactures a wide range of products in Sheffield UK. This range is supplemented by high quality product sourced from the EU with full CE certification.

This product is fully supported in the UK by:

Fairport Construction Equipment Ltd.
Blagden Street
Sheffield
S2 5QS



FAIRPORT

**For Parts
Accessories
and Service**

call:

0114 2767921

fax:

0114 2720965





email:

sales@fairport.uk.com

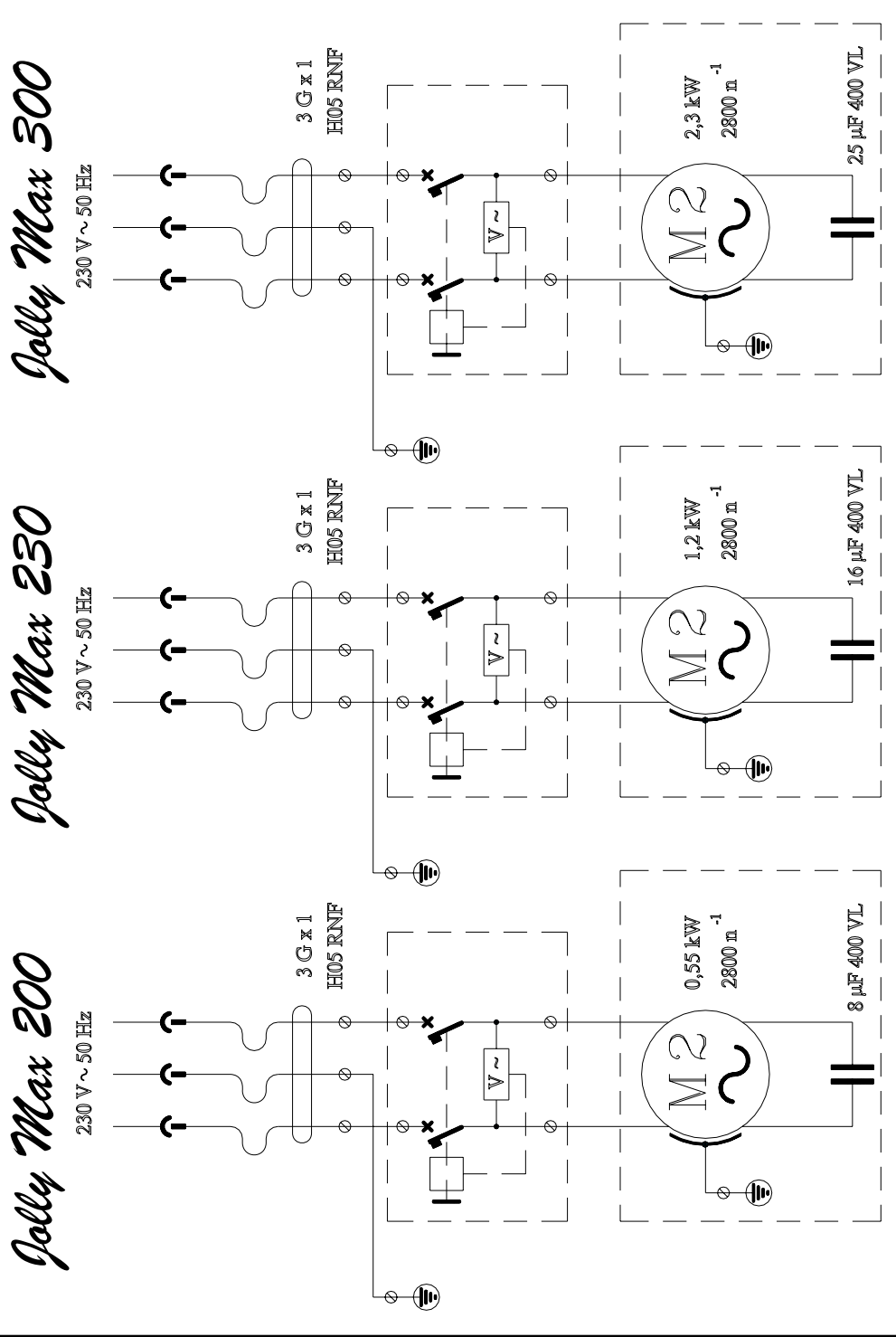
**For a PDF copy of
this manual visit:**

www.fairport.uk.com



| | | | |
|--|--|---|---|
| <p style="text-align: center;">(I)</p> <p>DICHIARAZIONE CE DI CONFORMITÀ</p> <p>Il sottoscritto, rappresentante il seguente costruttore</p> | <p style="text-align: center;">(GB)</p> <p>EC DECLARATION OF CONFORMITY</p> <p>The undersigned, representing the following manufacturer</p> | <p style="text-align: center;">(F)</p> <p>DECLARATION CE DE CONFORMITE</p> <p>Le soussigné, représentant le constructeur ci-après</p> | <p style="text-align: center;">(D)</p> <p>EG-KONFORMITÄTSERKLÄRUNG</p> <p>Der Unterzeichner, der den nachstehenden Hersteller vertritt</p> |
| <p>NUOVA BATTIPAV di Tondini C. & C. snc Z.i. 2 - Via Cavatorta, 6/1 - 48010 Cotignola (Ra) ITALY</p> | | | |
| <p>dichiara qui di seguito che la taglietina per ceramica, monocottura, marmo</p> | <p>herewith declares that the cutting machine for ceramic, single-firing ceramic, marble</p> | <p>déclare par la présente que le coupe-carreaux pour céramique, émail, monocoisson, marbre</p> | <p>erklärt hiermit, daß die Schneidmaschine für Keramikfliesen, einfach gebrannten Fliesen, Marmor</p> |
| <p>Mod. 860 230V ~ 50 Hz 0,55 Kw S6 30s / 90s 2800 min-1 MOTOR CLASS F</p> | <p>Mod. 880 230V ~ 50 Hz 1,2 Kw S6 30s / 90s 2800 min-1 MOTOR CLASS F</p> | <p>Mod. 040 230V ~ 50 Hz 2,3 Kw S6 30s / 90s 2800 min-1 MOTOR CLASS F</p> | <p>Mod. 040 230V ~ 50 Hz 2,3 Kw S6 30s / 90s 2800 min-1 MOTOR CLASS F</p> |
| <p>risulta in conformità a quanto previsto dalle seguenti direttive comunitarie: DIRETTIVA 98/37/CE, DIRETTIVA 89/336/CEE, DIRETTIVA 92/31/CEE, DIRETTIVA 93/68/CEE, DIRETTIVA 92/31/CEE, DIRETTIVA 73/23/CEE. e che sono state applicate tutte le norme e/o specifiche tecniche indicate.</p> | <p>is in conformity with the provisions of the following EC directives: 98/37, 89/336, 93/68, 92/31, 73/23, and that the standards and/or technical specifications referenced have been applied.</p> | <p>est conforme aux dispositions des directives CE suivantes: DIRECTIVE 98/37/CEE, DIRECTIVE 89/336/CEE, DIRECTIVE 93/68/CEE, DIRECTIVE 92/31/CEE, DIRECTIVE 73/23/CEE. et que les normes et/ou spécifications techniques ont été appliquées.</p> | <p>in Übereinstimmung ist mit den Bestimmungen der nachstehenden EG-Richtlinien: EG RICHTLINIE 89/37, EG RICHTLINIE 89/336, EG RICHTLINIE 93/68, EG RICHTLINIE 92/31, EG RICHTLINIE 73/23, und daß die Normen und/oder technischen Spezifikationen, zur Anwendung gelangt sind.</p> |
| <p>EN 55014, EN 50082-1, EN 60555-2, EN 60555-3, IEC 801-4, ISO 3745-77</p> <p>EN 61029-1 pr. EN 12418, EN 292-1, EN 292-2,</p> | | | |
| <p>Data di costruzione</p> | <p>Date of manufacture</p> | <p>Date de fabrication</p> | <p>Produktionsdatum</p> |
| <p>N° di Serie:</p> | <p>Series N.</p> | <p>N° de série</p> | <p>Seriennummer</p> |
| <p>Direttore Generale Claudio Tondini</p>  | <p>General Manager Claudio Tondini</p>  | <p>Le Directeur Général Claudio Tondini</p>  | <p>Der Generaldirektor Claudio Tondini</p>  |

GB**Technical data**

Power supply: 230V 50Hz.~

| JOLLY MAX 200 | JOLLY MAX 230 | JOLLY MAX 300 |
|---------------------|------------------|------------------|
| Max. absorbed power | | |
| 0,55 Kw | 1,2 Kw | 2,3 Kw |

Allowed functioning:

INTERMITTENT - S6-25% SERVICE

30 s functioning under load

90 s loadless functioning

Rotation Speed: 2800 min⁻¹

| Capacitor | | |
|-----------|------|------|
| 8µF | 16µF | 25µF |

| Weight | | |
|--------|-------|-------|
| 24 Kg | 30 Kg | 46 Kg |

| Tank capacity | | |
|---------------|------|------|
| 2 Lt | 2 Lt | 7 Lt |

Tool:

DIAMOND BLADE

| Cont. rim | Cont. rim | Cont. rim / Turbo |
|---------------------|-----------|-------------------|
| Blade diameter | | |
| 200 mm | 230 mm | 300 mm |
| Blade centre hole: | | |
| 25,4 mm | 25,4 mm | 30 mm |
| Max. cutting depth: | | |
| 30 mm | 35 mm | 70 mm |

Recommended use:

CERAMIC, SINGLE-FIRED CERAMIC, COTTO,

CLINKER, MARBLE AND PORCELAIN

STONEWARE (max. thickness 1 - 1.5 cm.)

The sound emitted by these machines is measured on production samples according to standard ISO 3745-77.

The machine was placed on an H800 (mm) auxiliary table.

The test was conducted with single-fired tiles 314x314x8 (mm), mod P3T287 1200 °C.

K = 2, [dB], pr EN 848 - 1.

Sound:

LOADLESS VALUES

Mod. 860

Lw 71,4 [dBW(A)] 0,0 [mW(A)]
Lpm 62,7 [dB(A)] 62,7 [dB(C)max]

Mod. 880

Lw 72,4 [dBW(A)] 0,0 [mW(A)]
Lpm 61,5 [dB(A)] 61,5 [dB(C)max]

Mod. 040

Lw 93,0 [dBW(A)] 2,0 [mW(A)]
Lpm 82,7 [dB(A)] 82,7 [dB(C)max]

UNDERLOAD VALUES

Mod. 860

Lw 101,5 [dBW(A)] 14,3 [mW(A)]
Lpm 92,0 [dB(A)] 100,7 [dB(C)max]

Mod. 880

Lw 103,5 [dBW(A)] 22,5 [mW(A)]
Lpm 93,3 [dB(A)] 102,0 [dB(C)max]

Mod. 040

Lw 112,0 [dBW(A)] 157,8 [mW(A)]
Lpm 103,0 [dB(A)] 112,1 [dB(C)max]

1. Use**CAUTION !**

Before using the machine read the safety instruction chapter carefully.

All machines have been thoroughly tested and checked before leaving our factory.

NUOVA BATTIPAV works for a continuous development of the machines the company manufactures, therefore the company reserves the right to modify its models. No rights can be therefore claimed as far as data and pictures of this manual are concerned.

The diamond blade cutting unit Mod. JOLLY MAX is a technologically advanced product, ideal for cutting even the hardest ceramic materials. The special wet-blade system totally eliminates the problem of dust normally produced during cutting operations.

Each tile cutter Mod. JOLLY MAX is ideal for cutting materials both at 90° (any length) and at 45° (Jolly).

2. Precautions

- The manufacturer declines any liability for the use of the electrical tile cutter JOLLY MAX with tools other than the original ones and for the cutting of materials not indicated in the paragraph "RECOMMENDED TOOLS".
- The machine Mod. JOLLY MAX is designed to work exclusively according to the ADMISSIBLE WORKING CONDITIONS indicated in the paragraph: "TECHNICAL DATA".
- During the cutting phase it is therefore recommended to interrupt the working cycle as indicated.
- The machine Mod. JOLLY MAX was not designed to work under continuous load.



Keep in mind following tips:

- Move the tile slowly to avoid jamming the blade;
- After a few cuts, sharpen the blade with a hone;

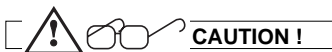

When cutting dangerous chips of glaze may break away.
To reduce the risks from fragments, wear appropriate protective goggles.



The use of machines by the same operator continuously over a period of eight hours may lead to daily personal exposure levels greater than 85 dB(A). To reduce the risks of exposure, use appropriate ear plugs according to the law.

3. Installation

Remove the machine from the packaging and check that no parts have been damaged.
Place the machine on a stable surface free of other material.
If a stand is used, check that it is stable.

4. Transport

JOLLY MAX tile cutters are easy to take around by using the specially provided side handles.
PRIOR TO TAKING IT AROUND, MAKE SURE THAT THE TILTING TABLE IS AT 45°

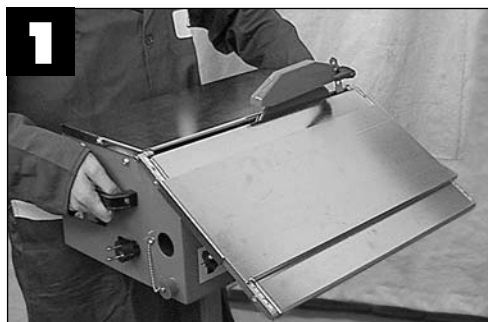

5. Connecting to power supply



The machine is to be connected to the mains by a residual current circuit breaker (RCCB) or class II isolation transformer with the following characteristics:

MOD. 860
RCCB **5 A Id 20 mA**

Transformer **230 V 50 Hz 650 W**
Cont. duty

MOD. 880
RCCB **10 A Id 20 mA**

Transformer **230 V 50 Hz 1500 W**
Cont. duty

MOD. 040
RCCB **16 A Id 20 mA**

Transformer **230 V 50 Hz 2500 W**
Cont. duty

N.B. To ensure correct functioning, periodically check the efficiency of the RCCBs by pressing the pushbutton on the front of the same.

Prior to connecting the machine to the power supply, make sure that the voltage is the same as the one indicated on the machine data plate.

GB

6. Adjusting the blade guard



Use the lock knobs to position the blade safety guard approximately ½ cm above the tile to be cut. (See picture 2)

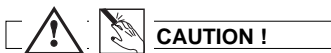
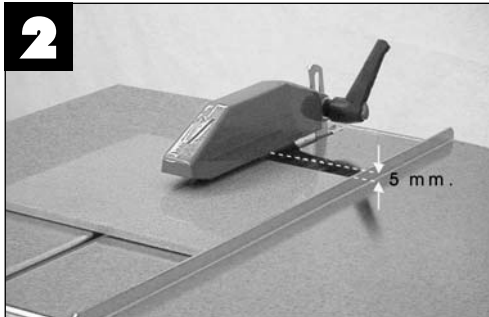

The machine is equipped with a continuous diamond perimeter blade. Even though this blade has been designed for operator safety if unintentionally touched, pay particular attention to avoid contact between your fingers and the blade during operation of the machine.

7. Checking before use



All JOLLY MAX machines are designed to OPERATE WITH WATER.

Prior to and during any cutting operation, make sure that the water level corresponds to the indications on the data plate on the side of the machine. Fill/top up through the hole as illustrated in the picture 3.



In particular cases, it may be necessary to use a basin to recover the cooling water. If so, use a basin with the following dimensions:

Mod. 860 = L 50 cm, P 60 cm, H 10 cm

Mod. 880 = L 60 cm, P 60 cm, H 10 cm

Mod. 040 = L 70 cm, P 60 cm, H 10 cm

8. Cutting at 90°



Position the cutting guide and lock it by tightening the knobs fully. (See picture 4)

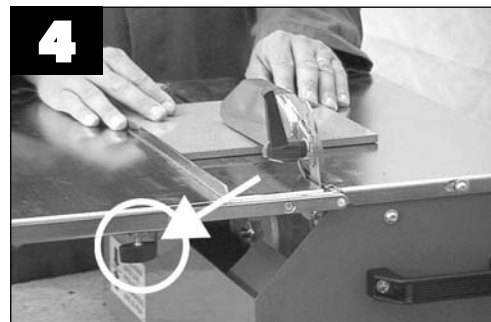

Picture 4 shows how to keep hands correctly during cutting at 90°.

The forward movement of the piece must be proportional to the blade cutting capacity, to prevent hazardous fragments that would involve accidents or injuries from breaking off.



CHECK THE WATER LEVEL.



Turn the cutting guide and increase the reading by 20 cm (See picture 5) in order to perform cutting lengths over 14 cm (Mod. JOLLY MAX 200) or over 20 cm (Mods. JOLLY MAX 230 / 300).

9. Cutting a surface at 45° (jolly)



CAUTION !

Position the tilting table at 45° by acting on its bearing rods.

Position the cutting guide making sure that the diamond blade does not meet the tile glaze. (See picture 6)



CAUTION !

CHECK THE WATER LEVEL.

10. Maintenance



CAUTION !

BEFORE PERFORMING ANY OPERATION DESCRIBED IN THIS CHAPTER, ENSURE THAT THE MACHINE IS DISCONNECTED FROM THE POWER SUPPLY.



DISASSEMBLY OF THE 45° SURFACE AND CLEANING

Use the 5 mm male hexagon wrench supplied to remove the tilting table securing screw. Let the tilting table slide from its support. Clean the blade flange lock nut and the thread of the motor shaft thoroughly. If necessary, spray with a releasing agent and leave it to act for a few minutes.

BLADE DISASSEMBLY

(MODS: 860 and 880)

Use the 4 mm male hexagon wrench supplied (Mod. 860) or the 7 mm wrench supplied (Mod. 880) to hold the motor shaft. Unscrew the blade flange lock nut with the 19 mm wrench.

(MOD. 040)

Insert the Ø6 rod supplied into the hole in the motor shaft. Use the 30 mm wrench supplied to unscrew the blade flange nut.



INFORMATION

After removing the blade, clean the blade flange thoroughly and check for wear.

Lubricate surfaces with fine oil, then fit new blade.



CAUTION !

CHECK THE ROTATION DIRECTION OF THE BLADE CAREFULLY; THE CORRECT DIRECTION IS CLEARLY MARKED BY AN ARROW ON EACH TOOL.

GB

REPLACING THE POWER SUPPLY CABLE

Replace power supply cable if necessary.

- Disassemble the working table by means of the 3 mm male hexagon wrench supplied.

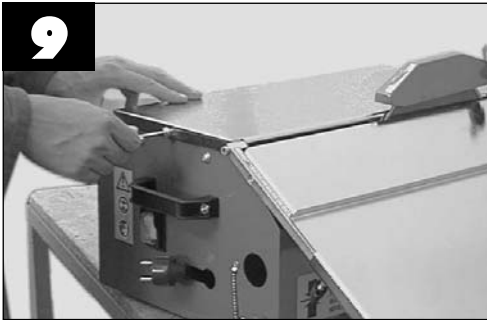

- Use a small-size flat screwdriver to remove the cover of the terminal board.
- Use a cross-headed screwdriver to disconnect the power supply and earth wires, then loosen the cable grip.
- Replace the cable, then reverse the disassembly procedure to reconnect.



11. Disposal

When parts wear out or when the machine is finally scrapped, waste disposal must be carried out in compliance with the laws in force.



Electric Motor

| | |
|-----------|----|
| Aluminium | AL |
| Steel | AC |
| Copper | CU |
| Polyamide | PA |

Main Body

| | |
|-------------|-----|
| Steel | AC |
| Polystyrene | PST |
| Polyamide | PA |

12. Troubleshooting

HAVE YOUR TOOL REPAIRED BY A QUALIFIED PERSON

This electric tool complies with the relevant safety rules. Repairs should only be carried out by qualified persons using original spare parts, otherwise this may result in considerable danger to the user.

| <u>Fault</u> | <u>Cause</u> | <u>Remedy</u> |
|--------------------------------|--|--|
| The machine does not function. | The power supply cable is damaged or not properly connected. | Press the plug firmly into the power socket. |
| | No voltage in the 230 V socket. | Have the 230 V socket checked. |
| | Switch is damaged. | Consult local dealer. |
| | Motor is under powered and gives off unpleasant odour. | Consult local dealer. |
| Machine is difficult to start. | Diamond blade is bent due to incorrect use | Replace diamond blade. |
| | Start capacitor is damaged. | Consult local dealer. |
| | Motor bearings are damaged. | Consult local dealer. |

SAFETY INSTRUCTIONS

Warning! When using electric tools, following safety precautions should always be followed to reduce the risk of fire, electric shock and personal injuries. Read and follow all these instructions before attempting to operate this product and save them with care!

SAVE THESE INSTRUCTIONS WITH CARE.

Keep your work area perfectly clean

- Cluttered areas invite injuries.

Consider work area environment

- Don't expose tools to rain.
- Don't use tools in damp or wet locations. Keep work area well lit.
- Don't use tools in presence of flammable liquids or gases.

Guard against electric shocks

- Prevent body contact with grounded surfaces.

Keep children away!

- Do not let third parties contact tool or extension cord. All visitors should be kept away from work area.

Store your tools in a safe place

- When not in use, tools should be stored in dry and safe places, out of the reach of children.

Don't force tool

- It will function better and in a safer way at the rate for which it was intended.

Use the right tool

- Don't use low duty tools or accessories to do the job of a heavy-duty tools. Don't use tools for purposes not intended.

Dress properly

- Rubber gloves and non-slip footwear are recommended when working outdoors. Wear protective hair covering to contain long hair. Use safety glasses.
- Use a mask if working operations are dusty.

Don't abuse cord

- Never carry tool by cord or yank it to disconnect it from socket.
- Keep cord from heat, oil and sharp edges.

Avoid unsteady positions

- Be sure to work in a safe and balanced position.

Maintain tools with care

- Keep tools sharp and clean for better and safer performance.
- Follow all maintenance advice and instructions to replace accessories subject to wear. Inspect tool cords periodically and, if damaged, have them repaired by an authorised expert. Check extension

cords periodically and replace them if damaged. Keep handles dry, clean and free from oil and grease.

Disconnect tools

- When not in use, before servicing, and when changing accessories subject to wear.

Remove service keys from tool

- Form the habit of checking to see that keys and adjusting wrenches are removed from tool before turning it on.

Avoid unintentional starting

- Be sure that the switch is off when plugging in the tool.

Extension cords for outdoor works

- When tool is used outdoors, use only extension cords intended for this particular use and so marked.

Stay alert

- Watch what you are doing. Use common sense. Do not operate tool when you are inattentive.

Check tool for damaged parts

- Before further use of the tool, check it and the safety devices for damages and be sure that they operate properly. Check for functioning and binding of moving parts, breakage of parts, correct mounting, and any other conditions that may affect the correct operation of the tool.
- Damaged safety devices or other parts should be properly repaired or replaced by an authorised Service Centre unless otherwise indicated elsewhere in this instruction manual.
- Have defective switches replaced by an authorised Service Centre.
- Do not use tool if its switch cannot be turned on or off.

Warning

- For your personal safety use only accessories recommended in this instruction manual or in the relevant catalogues. The use of any other accessory or attachment other than those recommended in this instruction manual or in the relevant catalogue may present a risk of personal injury.

Have tools repaired by qualified personnel

- This electric appliance is in accordance with the safety rules in force. Only qualified experts may carry out repairing of electric appliances otherwise it may cause considerable danger for the user.